

SUB210V SUB210VW

User's manual

SPECIFICATIONS

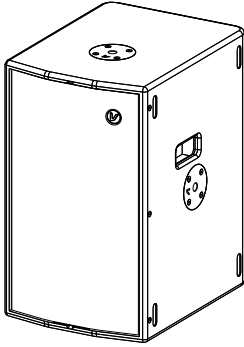

SUB210V series is a high power compact subwoofer made with 2 ferrite magnet 10" drivers that can deliver a peak SPL up to 131dB. The 18mm panels thickness, ports placement and internal bracing stiffens the cabinet structure avoiding undesirable vibrations.

The sound is deep, punchy, clear and free of phase distortion. It can be used in mobile applications or fix indoor installations where a good sounding and high SPL is needed.

Acoustics

Continuous power : 800W (AES)
Program power : 1600W
Impedance: 4Ω
Sensitivity: 96dB 1W/1m
Max. SPL @1m: >131dB
Frequency response: 36Hz-2.5kHz (-10dB)

Speaker components

2 x 10" ferrite magnet 2.5" VC long excursion
European driver

Connectors

2x NEUTRIK® Speakon NL4
(±1 INPUT/ ±2 LINK)

Cabinet

CNC made 18mm birch multi-layer plywood
sand texture and weather-resisting
protection paint

Mounting

2 x M20 threaded insert for pole assembly

Recommended amplifier power

1600W at 4Ω

Recommended HP filter

35Hz - 24dB/oct

Size/Package Size :

W356xH590xD470 / W500xH710xD600mm

N.W/G.W

31kg/34.5kg

CURVES :

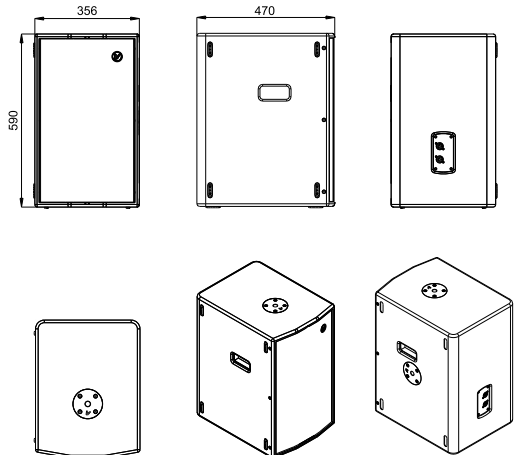
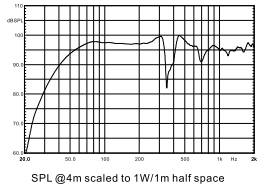
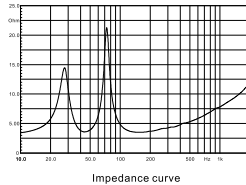

Wiring :

- ±1, SUB/INPUT
- ±2, Full range/LINK

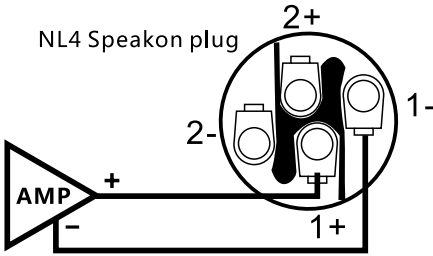

WIRING

INPUT	1+	1-
LINK	2+	2-

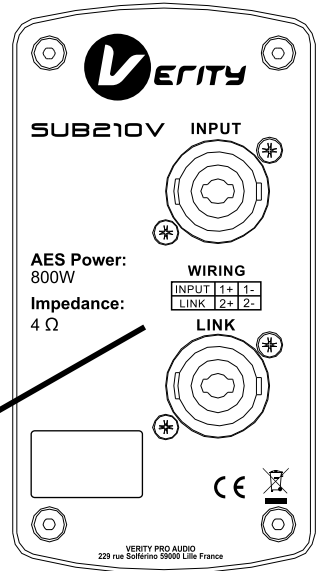

When SUB210V is in the same place with full range speaker , we suggest to use 4 core cable, can save time and cable. Like the picture on the right.

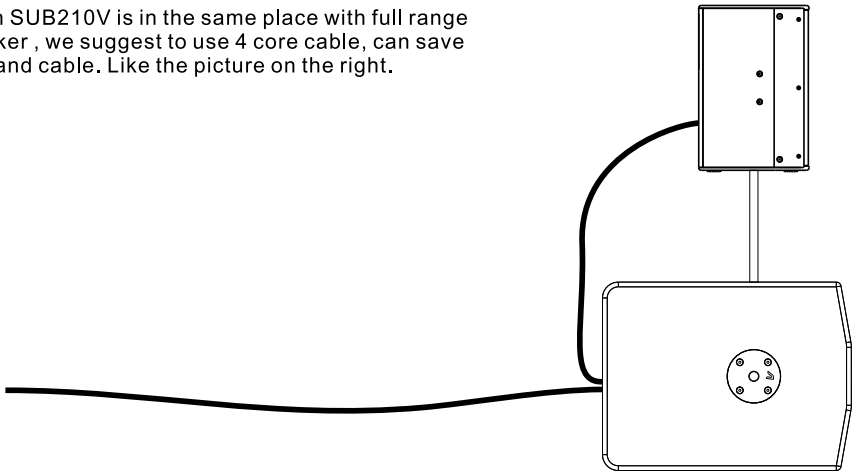



Verity Audio reserves the right to make any changes to the product specifications without prior notice.
Final specifications to be found in the user manual.